

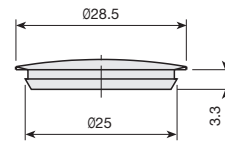

**1** EXCÉNTRICA Y TAPAS

Tapa Ø25mm.

|           |          |             |  |
|-----------|----------|-------------|-----------------------------------------------------------------------------------|
| Blanco    | RAL 9003 | 530.400.006 |                                                                                   |
| Marrón    | RAL 8016 | 530.400.010 | 2.000                                                                             |
| Negro     | RAL 9005 | 530.400.021 |                                                                                   |
| Gris      | RAL 7040 | 530.400.312 |                                                                                   |
| Niquelado |          | 530.400.065 | 1.000                                                                             |



Tapa con tetones Ø25mm.

|        |          |             |  |
|--------|----------|-------------|-----------------------------------------------------------------------------------|
| Blanco | RAL 9003 | 530.100.001 |                                                                                   |
| Marrón | RAL 8016 | 530.100.012 | 2.000                                                                             |
| Negro  | RAL 9005 | 530.100.023 |                                                                                   |

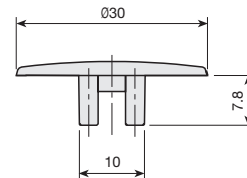

Excéntrica Ø25mm.

|         |  |             |  |
|---------|--|-------------|-------------------------------------------------------------------------------------|
| Natural |  | 510.011.106 | 2.000                                                                               |

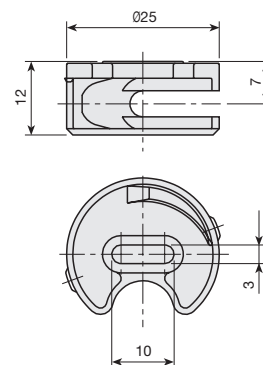

2 PERNOS

Perno r/madera.

Distancia de taladrado 33mm.

Cincado 520.839.034 2.000

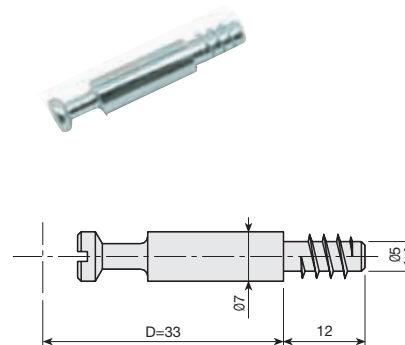
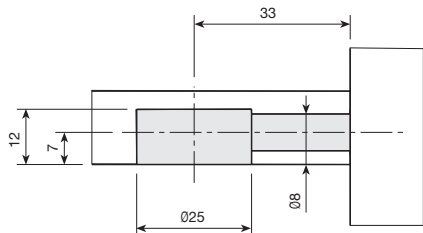

Perno M6.

Distancia de taladrado 33mm.

Cincado 520.735.036 2.000

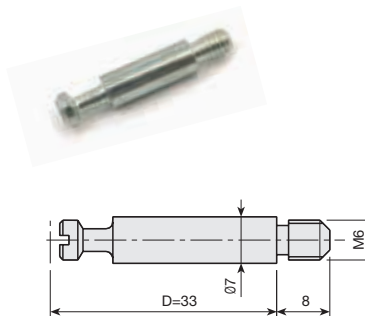
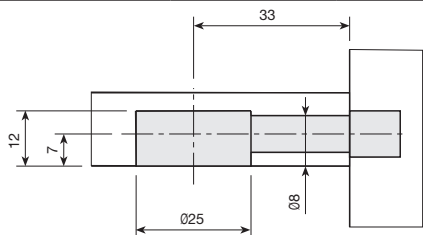

Perno doble cuello.

Cincado 522.077.032 1.000

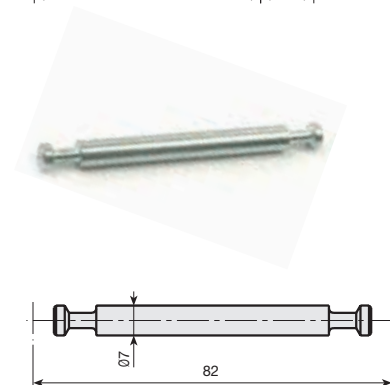
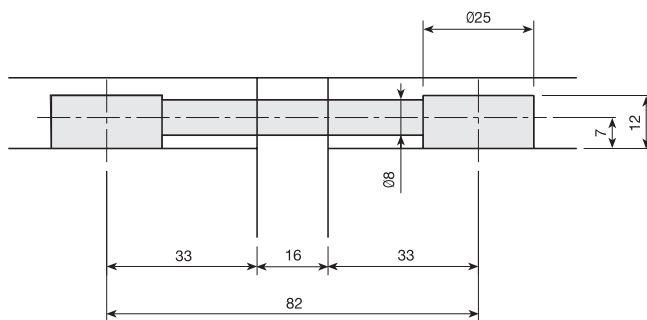

Perno doble cuello a escuadra.

Cincado 522.100.036 1.000

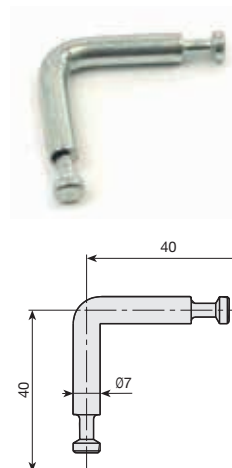
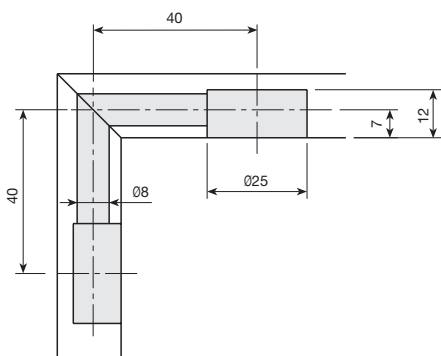

3 TUERCAS

Tuerca rosca madera de acero, sin cabeza.

| Cincado |         |          |             |             |                                                                                   |
|---------|---------|----------|-------------|-------------|-----------------------------------------------------------------------------------|
| L (mm.) | Ød(mm.) | ØD (mm.) | 1/4"        | M6          |  |
| 10      | 8       | 10       | 947.510.034 | 947.810.032 | 2.500                                                                             |
| 12      | 8       | 10       | 947.512.031 | 947.812.036 | 2.000                                                                             |
| 14      | 8       | 10       | 947.514.035 | 947.814.033 | 2.000                                                                             |
| 18      | 8       | 10       | 947.518.036 | 947.818.034 | 2.000                                                                             |
| 22      | 8       | 10       | 947.522.030 | 947.822.035 | 2.000                                                                             |
| 10      | 9       | 12       | 947.610.031 | 947.910.036 | 2.000                                                                             |
| 12      | 9       | 12       | 947.612.035 | 947.912.033 | 2.000                                                                             |
| 14      | 9       | 12       | 947.614.032 | 947.914.030 | 2.000                                                                             |
| 16      | 9       | 12       | 947.616.036 | 947.916.034 | 2.000                                                                             |
| 18      | 9       | 12       | 947.618.033 | 947.918.031 | 2.000                                                                             |

| L (mm.) | Ød(mm.) | ØD (mm.) | M8          |  |
|---------|---------|----------|-------------|-----------------------------------------------------------------------------------|
| 22      | 11      | 14       | 948.222.030 | 1.500                                                                             |

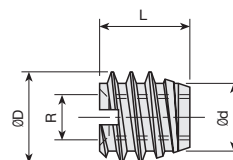

Tuerca expansible de latón.

| M4          |  |
|-------------|-------------------------------------------------------------------------------------|
| 944.805.105 | 2.000 ó 10.000                                                                      |

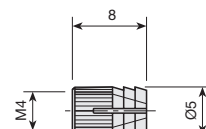

Tuerca autoexpansible de latón M6.

| M6                     |  |
|------------------------|-------------------------------------------------------------------------------------|
| Ø8 x 12mm. 944.112.105 | 5.000                                                                               |

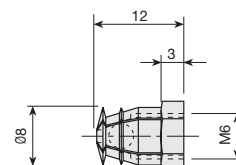

Tuerca de aletas.

| 1/4"                  | M6          |  |
|-----------------------|-------------|-------------------------------------------------------------------------------------|
| Níquelado 948.813.062 |             | 2.000                                                                               |
| Cincado               | 948.913.033 |                                                                                     |

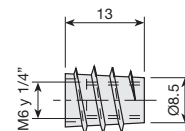

Tuerca de aletas con cabeza.

| M4        | 1/4"        | M6          | M8          |  |
|-----------|-------------|-------------|-------------|-------------------------------------------------------------------------------------|
| Níquelado | 948.613.061 |             |             | 2.000                                                                               |
| Cincado   | 948.413.034 | 948.713.032 | 948.575.036 |                                                                                     |

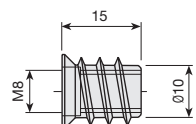
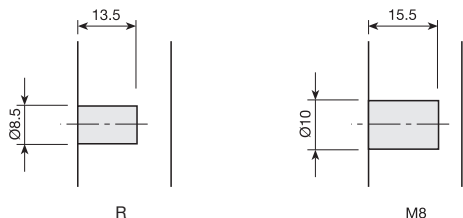
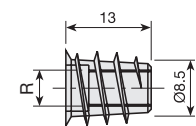

**Tuerca empotrable de nylon M4 para Ø8.**

|         |          |             |  |
|---------|----------|-------------|-----------------------------------------------------------------------------------|
| Natural |          | 937.004.106 | 2.000 ó 10.000                                                                    |
| Marrón  | RAL 8016 | 937.004.014 |                                                                                   |

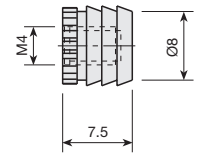

**Tuerca empotrable de nylon para Ø10.**

| R       | M6                   | 1/4"        |  |
|---------|----------------------|-------------|-----------------------------------------------------------------------------------|
| Natural | 937.006.103          | 937.014.105 | 2.000 ó 10.000                                                                    |
| Marrón  | RAL 8016 937.006.011 | 937.014.013 |                                                                                   |
| Negro   | RAL 9005 937.006.022 | 937.014.024 |                                                                                   |

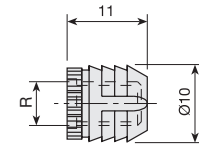

**Tuerca empotrable de nylon para Ø11.**

| R       | M6                   | 1/4"        |  |
|---------|----------------------|-------------|-------------------------------------------------------------------------------------|
| Natural | 937.106.100          | 937.114.102 | 4.000                                                                               |
| Marrón  | RAL 8016 937.106.015 | 937.114.010 |                                                                                     |

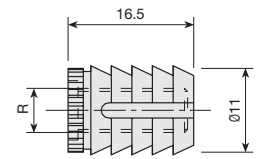

**Tuerca empotrable de nylon M6 para Ø10, en tiras.**

|         |          |             |  |
|---------|----------|-------------|-------------------------------------------------------------------------------------|
| Natural |          | 937.406.105 | 4.800                                                                               |
| Marrón  | RAL 8016 | 937.406.013 |                                                                                     |
| Negro   | RAL 9005 | 937.014.024 |                                                                                     |

Cada caja contiene 200 tiras.  
Se ofrecen tiras de 24 piezas; su colocación puede ser manual o por medio de pistola neumática con cargador.

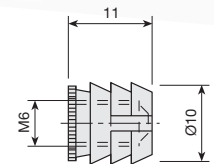
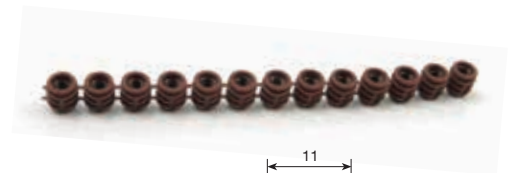

**Tuerca empotrable moleteada de acero M6.**

| L       | 16mm.       | 18mm.       |  |
|---------|-------------|-------------|-------------------------------------------------------------------------------------|
| Cincado | 938.716.100 | 938.718.104 | 1.000 ó 5.000                                                                       |

